

C4152 ACE II CAM TYPE UNIVERSAL

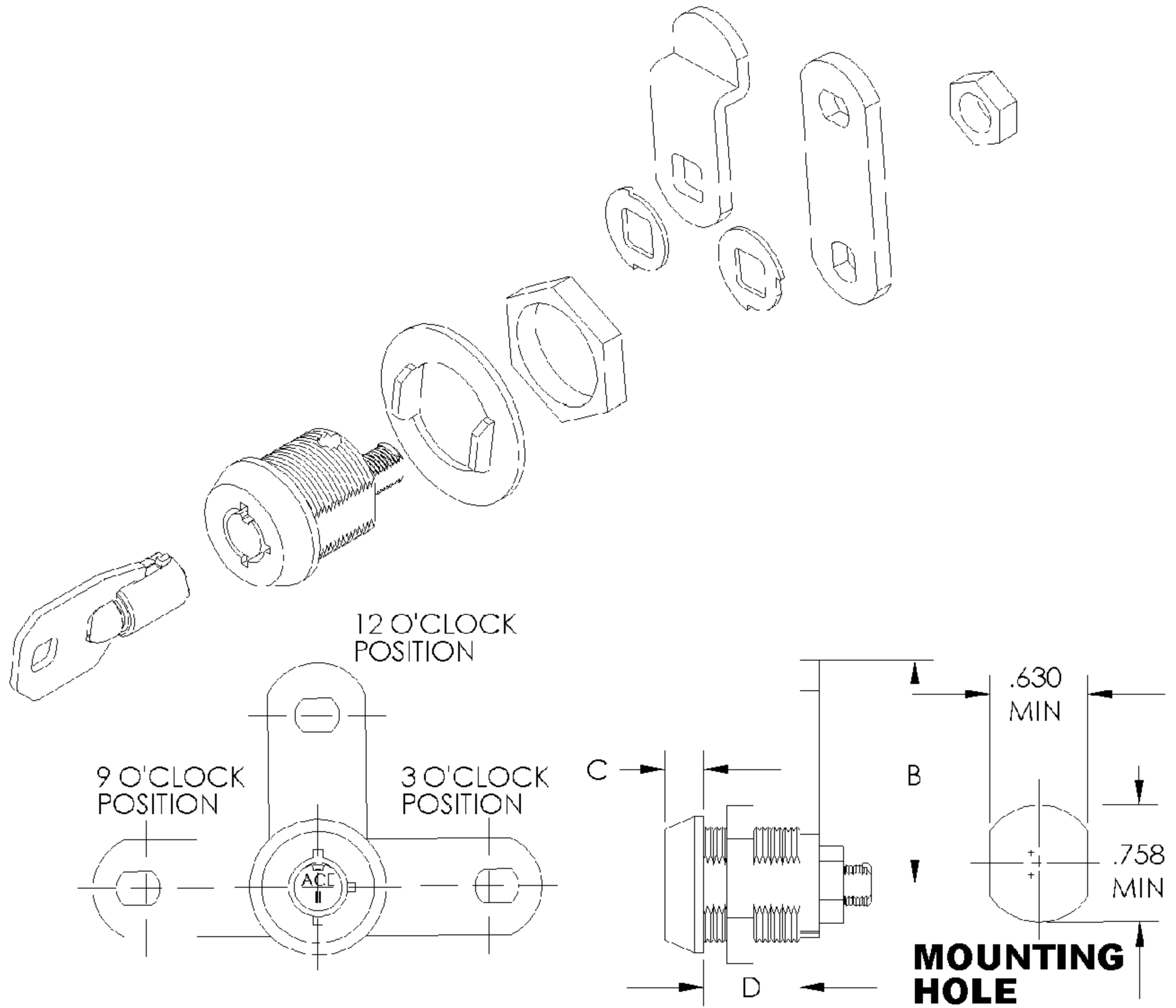

LOCK NO.	B DIM	C DIM	D DIM
C4198	1 1/8" 28.6 mm	23/64" 9.04 mm	19/32" 15.1 mm
C4153	1 1/8" 28.6 mm	1/4" 6.4 mm	11/16" 17.5 mm
C4152	1 1/8" 28.6 mm	13/64" 5.2 mm	15/16" 23.8 mm
C4160	1 1/8" 28.6 mm	13/64" 5.2 mm	1 3/32" 27.8 mm