

4520 & 4920 SERIES DOUBLE CYLINDER DEADBOLTS

Installation Instructions

0001-10-8190-13

TOOLS NEEDED FOR INSTALLATION

Drill • 2 1/8" Drill Bit • 1" Drill Bit
3/16" Drill Bit • 5/32" Drill Bit
Phillips Screwdriver • Chisel
Allen Wrench (Supplied with Lock)

- 1 MARK HOLES**
Using enclosed template, mark door as illustrated at desired lock height.

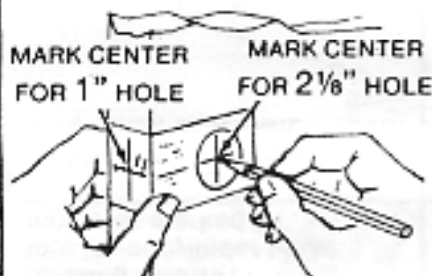

- 2 BORE TWO HOLES**
A. Bore 2 1/8" hole until point of drill breaks through. Then complete hole from other side. This prevents splintering.
B. Bore 1" hole from edge of door. (See Template)

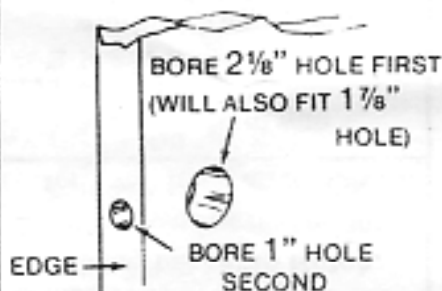

- 3 MORTISE FOR FRONT**
Mortise (recess) for front 5/32" Deep on edge of door. Use front as template.

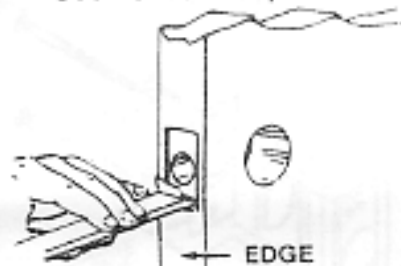

- 4 A. Install cylinder housing assembly into large hole in door with "TOP" upright**

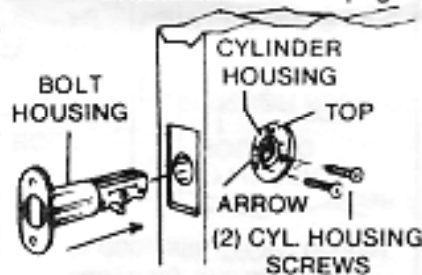

- B. Insert bolt housing into 1" hole thru cylinder housing.
C. Screw in (2) cylinder housing screws (1" long) into lower cylinder housing holes marked "A".

- 5 A. Assemble cylinder* and wave washer into cylinder rose.**

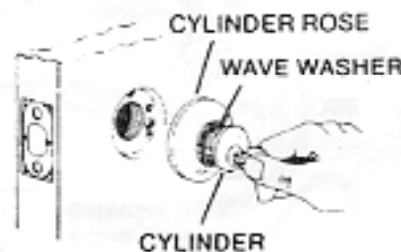

- B. Insert key in cylinder. Pull key back **One Notch**.
C. Note: include cylinder ring for 1 3/8" thick doors **ONLY**.

- 6 A. Screw cylinder into housing until it stops. (Use key as wrench).**
B. Reverse rotation of cylinder at least one turn.

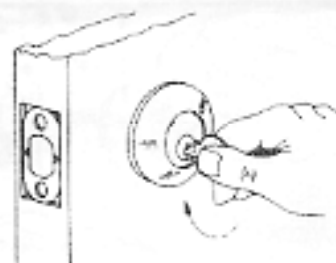

- C. Assemble 2nd Cylinder same method.

- 7 A. Make sure cylinders line up on both sides of door as shown.**

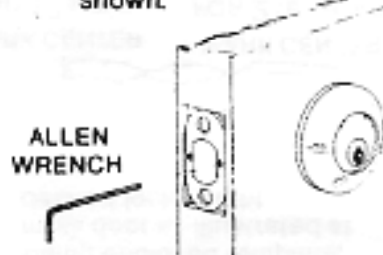

- B. Insert Allen wrench inside along each side of bolt until it engages screw and tighten two cylinder set screws into "V" notches in cylinder.

- 8 A. Attach front with two screws.**

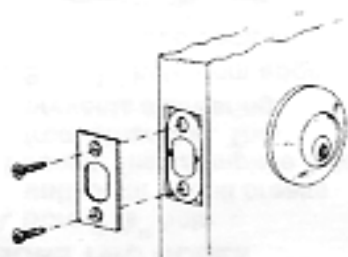

- B. Try key on both sides and operate bolt.

INSTALL STRIKE REINFORCER AND STRIKE

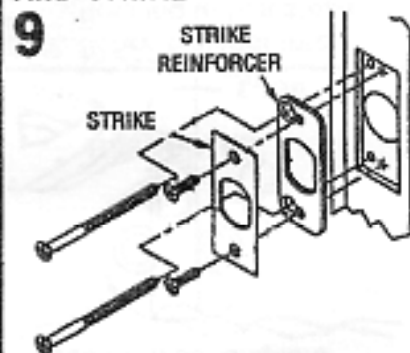

- 9**
A) Drill 1" dia. hole in line with bolt in door jam 1" deep.
B) Using strike as a template, mortise out 5/32" deep.
C) Position strike reinforcer in mortised area with (2) larger screw holes closest to the door stop. Mark these (2) holes & drill (2) 3/16 dia. holes 3" deep.
D) Position strike reinforcer & attach (2) 3" long screws.
E) Position strike & attach (2) short screws.